

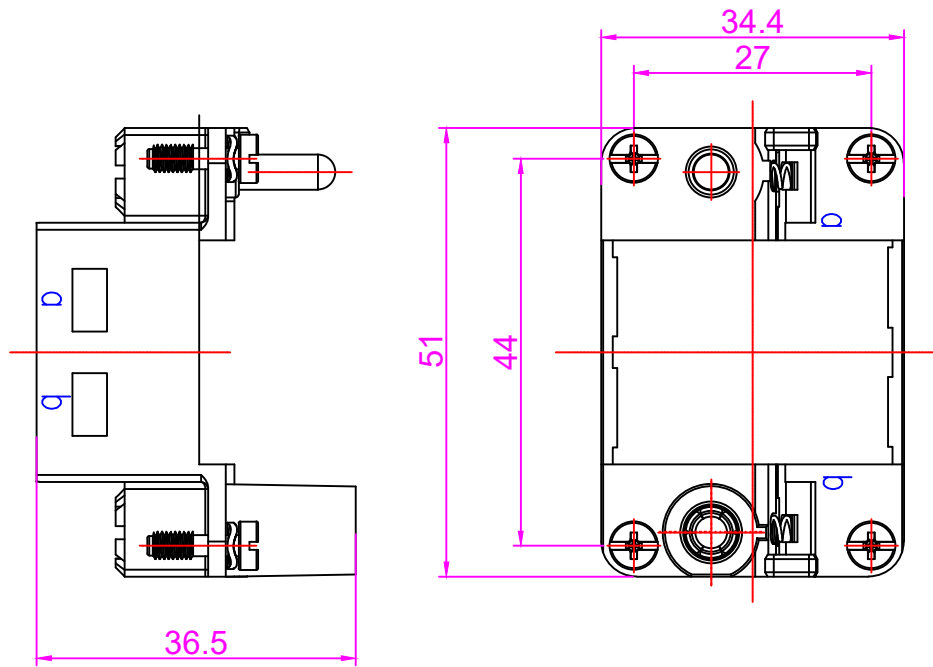

REVISION DATA				
SYM	ECN	DESCRIPTION	DATE	APPROVED

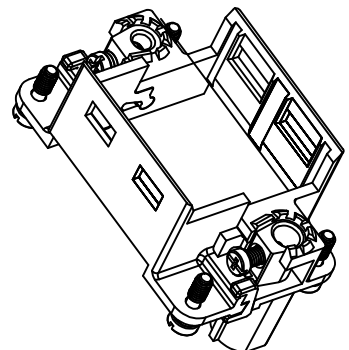

技术参数:
 材料: 锌合金
 表面处理: 镀锌
 温度范围: $-40^{\circ}\text{C} \sim +125^{\circ}\text{C}$
 模块数量: 2
 接地线、
 功率线: $4 \sim 10\text{mm}^2$ (AWG12-8)
 信号线: $1 \sim 2.5\text{mm}^2$ (AWG18-14)
 插拔次数: ≥ 500

Specifications:
 Material: zinc alloy
 Surface: Galvanization
 Limiting temperatures: $-40^{\circ}\text{C} \sim +125^{\circ}\text{C}$
 Number of modules: 2
 PE contact,
 Power side:
 Wire gauge-- mm^2 : 4.0~10 mm^2
 Wire gauge--AWG: 12-8
 Signal side:
 Wire gauge-- mm^2 : 1.0~2.5 mm^2
 Wire gauge--AWG: 18-14
 Mechancial working life (Mating cycles): ≥ 500



Tolerance		SIGNATURE	DATE	Units	mm	 宁波欧科瑞连接器有限公司 NINGBO OUKERUI CONNECTOR CO., LTD.	
0~ ≤ 20	± 0.15	DRAW		Size	A4		
20~ ≤ 50	± 0.25	DESIGN		Scale		PART NAME: HZW-HF6B-LA	
50~ ≤ 80	± 0.35	CHECK		Sheet		Drawing NO.	REV
80~ ≤ 120	± 0.50	APPROVE		Proj.		Material	A