

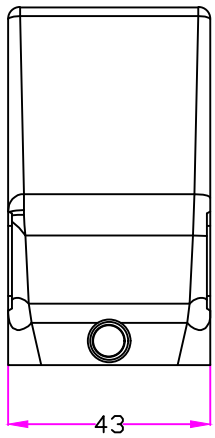

REVISION DATA				
SYM	ECN	DESCRIPTION	DATE	APPROVED

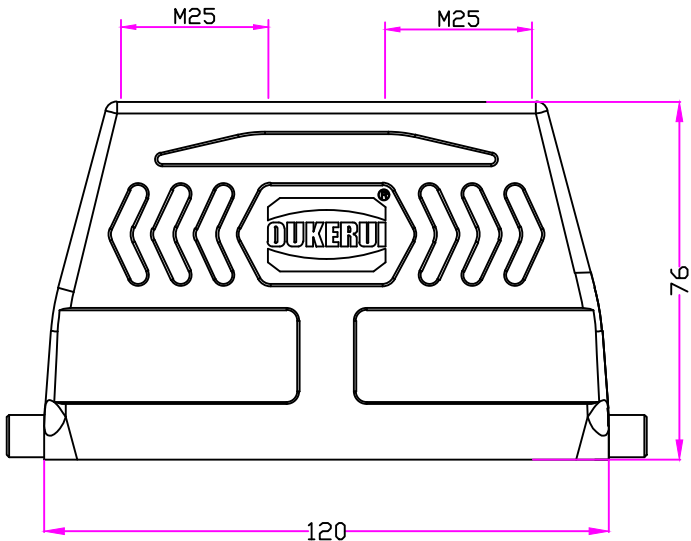

技术参数:  
 材料: 压铸铝  
 表面处理: 粉末喷涂  
 颜色: RAL7037灰色  
 温度范围: -40℃~+125℃  
 防护等级: IP65(联锁状态)  
 出线方向: 顶出线  
 螺纹规格: 2M25

Specifications:  
 Material: aluminium die-cast  
 Surface: powder-coated  
 Color: Grey (RAL 7037)  
 Limiting temperatures: -40℃~+125℃  
 Degree of protection: IP65  
 Cable entry: top entry  
 Thread size: 2M25

Tolerance		SIGNATURE	DATE	Units	mm	 宁波欧科瑞连接器有限公司 NINGBO OKERUI CONNECTOR CO., LTD.
0~≤20 ±0.15	DRAW			Size	A4	
20~≤50 ±0.25	DESIGN			Scale		PART NAME: HZW-H24B-TKH-2g-2M25
50~≤80 ±0.35	CHECK			Sheet		Drawing NO.
80~≤120 ±0.50	APPROVE			Proj.		Material
						REV
						A