

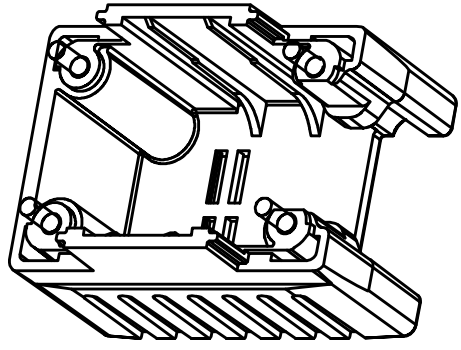

REVISION DATA				
SYM	ECN	DESCRIPTION	DATE	APPROVED

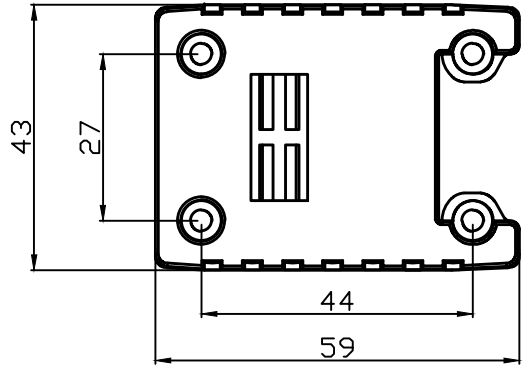
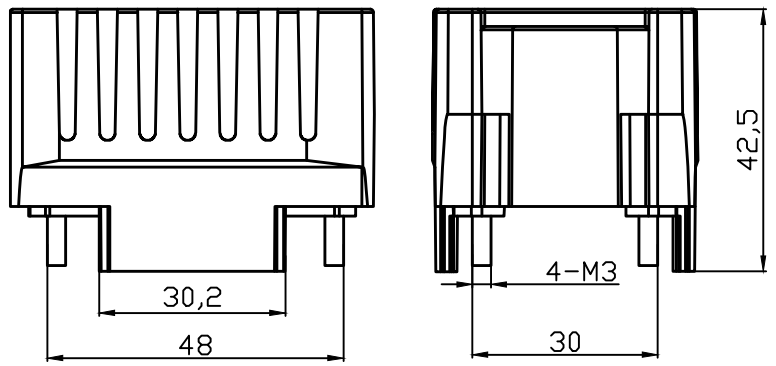

技术参数:  
 材料: PC  
 对插芯起保护作用  
 Technical specification:  
 -Material: PC  
 Play the protective role for insert

Tolerance		SIGNATURE	DATE	Units	mm	 宁波欧科瑞连接器有限公司 NINGBO OUKERUI CONNECTOR CO.,LTD.	
0~≤20 ±0.15	DRAW			Size	A4		
20~≤50 ±0.25	DESIGN			Scale		PART NAME: HZW-CC6B-CV	
50~≤80 ±0.35	CHECK			Sheet		Drawing NO.	REV
80~≤120 ±0.50	APPROVE			Proj.		Material	A