

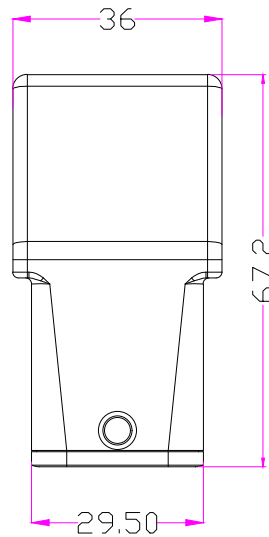

REVISION DATA				
SYM	ECN	DESCRIPTION	DATE	APPROVED

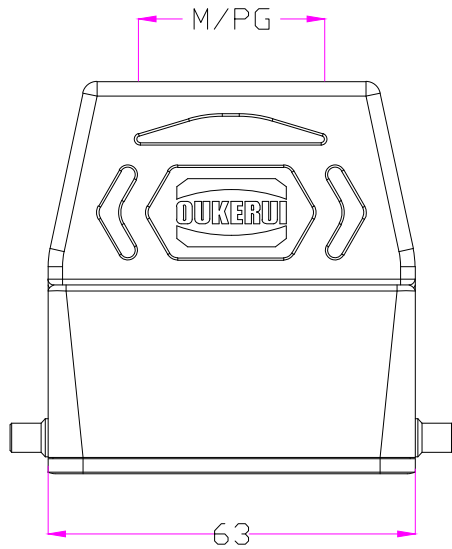

技术参数：
 材料：压铸铝
 表面处理：粉末喷涂
 颜色：RAL7037灰色
 温度范围：-40℃~+125℃
 防护等级：IP65(联锁状态)
 密封元件：NBR
 出线方向：顶出线
 螺纹规格：M25/PG16/PG21

Specifications:
 Material: aluminium die-cast
 Surface: powder-coated
 Color: Grey (RAL 7037)
 Limiting temperatures: -40℃~+125℃
 Degree of protection : IP65
 Hoods/Housings sealing: NBR
 Cable entry: top entry
 Thread size: M25/PG16/PG21



Tolerance		SIGNATURE	DATE	Units	mm	 宁波欧科瑞连接器有限公司 NINGBO OUKERUI CONNECTOR CO.,LTD.	
0~≤20 ±0.15	DRAW			Size	A4		
20~≤50 ±0.25	DESIGN			Scale		PART NAME: HZW-H10A-TKH-2g-M/PG	
50~≤80 ±0.35	CHECK			Sheet		Drawing NO.	REV
80~≤120 ±0.50	APPROVE			Proj.		Material	A