

		REVISION DATA			
SYM	ECN	DESCRIPTION	DATE	APPROVED	

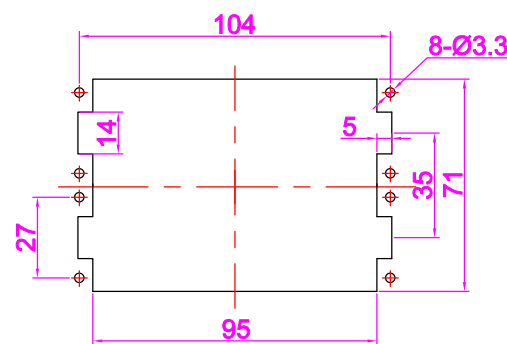
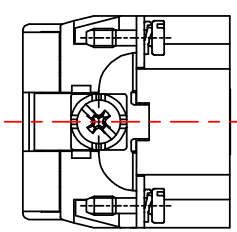
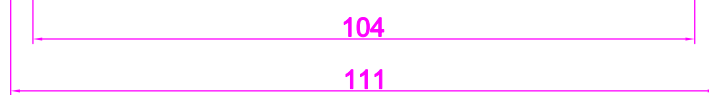
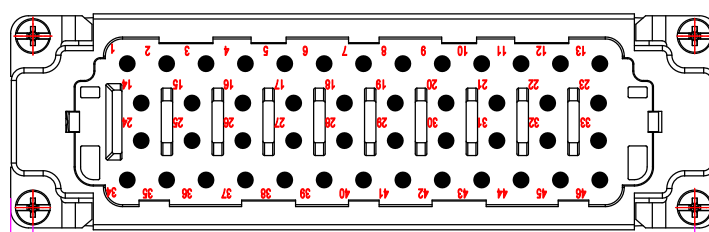
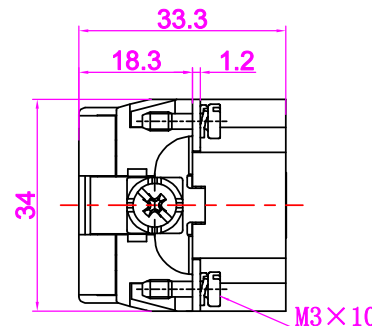
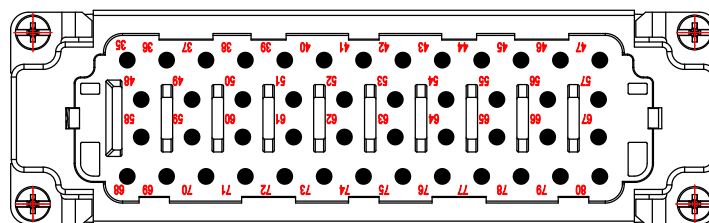

技术参数:
 插芯:
 插针数: 92+PE
 额定电流: 16A
 工作电压: 500V
 额定脉冲电压: 6KV
 污染等级: 3
 依据UL/CSA的额定电压: 600V
 绝缘阻抗: $\geq 10^{10} \Omega$
 材料: 聚碳酸酯
 温度范围: $-40^{\circ}\text{C} \sim +125^{\circ}\text{C}$
 依据UL94的阻燃等级: V0
 可插拔次数: ≥ 500

Specifications:
 Inserts:
 Number of contacts: 92+PE
 Rated current: 16A
 Rated voltage: 500V
 Rated impulse voltage: 6KV
 Pollution degree: 3
 Rated voltage acc. to UL/CSA: 600V
 Insulation resistance: $\geq 10^{10} \Omega$
 Material: Polycarbonate
 Limiting temperatures: $-40^{\circ}\text{C} \sim +125^{\circ}\text{C}$
 Flammability acc. to (UL94): V0
 Mechanical working life -mating cycles: ≥ 500

插针:
 接线方式: 冷压连接
 材料: 铜合金
 表面处理: 镀银/镀金
 接触电阻: $\leq 1\text{m}\Omega$
 线径范围: 0.14~4.0mm² (AWG26-14)
 剥线长度: 7.5mm

Contacts:
 Terminal: Crimp terminal
 Material: Brass
 Surfac: hard-silver plated/Gold plated
 Contact resistance: $\leq 1\text{m}\Omega$
 Crimp terminal
 Wire gauge—mm²: 0.14~4.0mm²
 Wire gauge—AWG: 26-12
 Stripping length: 7.5mm

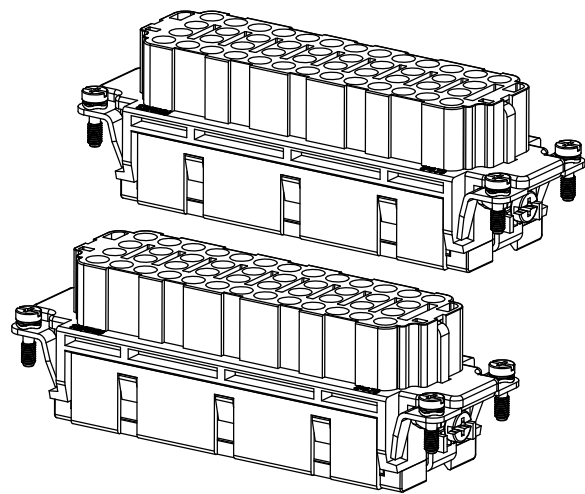

面板开孔图
 Panel cut

Tolerance		SIGNATURE	DATE	Units	mm	宁波欧科瑞连接器有限公司 NINGBO OUKERUI CONNECTOR CO., LTD.	
0~ ≤ 20	± 0.15	DRAW		Size	A4		
20~ ≤ 50	± 0.25	DESIGN		Scale			
50~ ≤ 80	± 0.35	CHECK		Sheet			
80~ ≤ 120	± 0.50	APPROVE		Proj.			
						PART NAME: HZW-HEE-092-FC	
						Drawing NO.	REV
						Material	A